

EXPERIMENT MANUAL



# MAGNETIC SCIENCE

 THAMES & KOSMOS

## What's in your experiment kit:



## Checklist: Find – Inspect – Check off

✓	No.	Description	Qty.	Item No.
<input type="checkbox"/>	1	Ring magnets (4) with stand	1	704 443
<input type="checkbox"/>	2	Block magnet	1	704 444
<input type="checkbox"/>	3	Ball magnets (set of 3)	1	709 255
<input type="checkbox"/>	4	Plastic chips (approx. 25)	1	704 446
<input type="checkbox"/>	5	Horseshoe and bar magnet set	1	704 447
<input type="checkbox"/>	6	Compass	1	000 276
<input type="checkbox"/>	7	Iron powder in plastic box	1	704 449
<input type="checkbox"/>	8	Iron rod	1	011 297
<input type="checkbox"/>	9	Wire	1	000 064
<input type="checkbox"/>	10	Polystyrene disk	1	702 235
<input type="checkbox"/>	11	Multicolored cardboard strip	1	709 280

Before doing anything else, please check all the parts against the list to make sure that nothing is missing. If you are missing any parts, please contact Thames & Kosmos customer service.

## Additional things you will need:

1.5-volt AA battery, scissors, adhesive tape, glue stick, paper, cardboard, permanent marker, string, ruler, bowl, saucer, needle, spoon, water, stopwatch, thick paper, various magnetic and nonmagnetic objects from around the house

Any materials not contained in the kit are marked in *italic script* in the “You will need” boxes.

## Magnets, Iron, and Poles

### Pages 3 to 19

Learn all about the properties of your magnets.



## Compass

### Pages 20 to 25

How Christopher Columbus found his way across the open seas

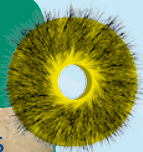
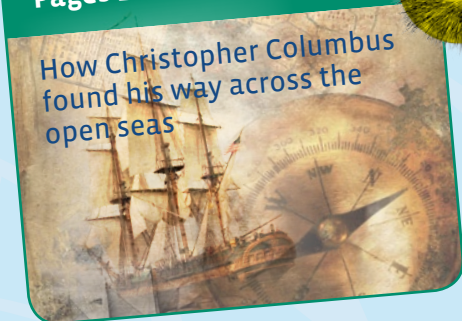

## Magnetic Force and Magnetic Fields

### Pages 26 to 36

How to make invisible magnetic fields visible

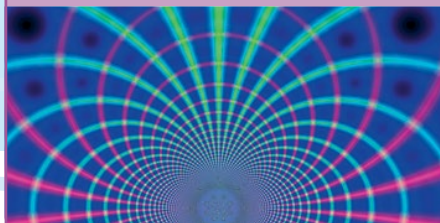

## Electromagnetism

### Pages 37 to 43

Build your own electromagnet.



# Games

with Magnets  
Pages 44 to 48



## CHECK IT OUT

You will find supplemental information on pages 18, 19, 25, 35, 36, 42, and 43.



Dear

**Parents**

This experiment kit uses lots of interesting experiments to give your child a playful introduction to magnets and magnetism. Please stand by your child's side during the experiments and offer your support and guidance. Before starting the experiments, read through the manual together and be sure to follow it when performing the experiments. Please be careful not to let any of the kit parts get into the hands of young children. Have fun with the experiments!

**Warning!** Do not bring the magnets close to television sets, computers, computer diskettes, music cassettes, videotapes, or ATM or credit cards. The data stored in them could be damaged or lost!

- For the experiments, you will need one 1.5-volt AA-type penlight battery, which could not be included in the kit due to its limited shelf life.
- Under no circumstances are more or different batteries to be used than what is specified here.
- Do not use rechargeable batteries.
- Never try to recharge non-rechargeable batteries. They could explode!
- Never bring batteries into contact with other metal objects, such as key rings or coins.
- Avoid bending or distorting batteries.
- Never throw batteries into flame or store them near heat sources.
- Do not use electrical outlets for any experiments! Never insert wires or other

## IMPORTANT INFORMATION

metal pieces into outlets! The electrical voltage (110 volts) can kill you!

- When experimenting, avoid connecting the battery terminals directly to each other — the battery could explode!
- Avoid short-circuiting the battery or batteries.
- After the experiments, always completely disconnect the electrical or electromagnetic circuit from the battery and store separately.
- Dead, used-up batteries are to be disposed of properly at collection locations, not simply thrown into the trash.
- Do not mix old and new batteries.
- Do not mix alkaline, standard (carbon-zinc), or rechargeable (nickel-cadmium) batteries.

**WARNING!** Not suitable for children under 8 years. This product contains small magnets. Swallowed magnets can stick together across intestines causing serious injuries. Seek immediate medical attention if magnets are swallowed.

**CAUTION!** Some parts of this kit have pointed or sharp corners or edges due to their function. Do not injure yourself!

**CAUTION!** Not suitable for children under 3 years of age. There is a risk of choking or suffocation, since small parts could be swallowed or inhaled.

Save packaging and instructions, as they contain important information.



# Magnets, Iron and Poles

Over 2,500 years ago, scientists in ancient Greece made an astonishing discovery: Chunks of certain rocks exert a mysterious power over things made of iron. Since these rock chunks were primarily found near the ancient town of Magnesia in Asia Minor, they were called magnets. Today, magnets play an important role in many everyday and technical devices. You may know about magnetic closures on kitchen cupboard doors, for example. But you'll also find magnets in speakers, in bicycle dynamos, and in multiple locations in cars.

Now it's time to learn about the mysterious nature of magnets...

# Lots of magnets

## YOU WILL NEED

→ all of the parts inside this kit

## HERE'S HOW

1. Take all the parts except the magnets out of the experiment kit box and place them on a table.
2. Now take the bar magnet and watch what happens when you touch the objects on the table with it.

What do you notice?

Do the same thing with the horse-shoe magnet, the block magnet, and the ball magnet.

## → WHAT'S HAPPENING?

There are various types of magnets in your experiment kit. All of them will have an effect on the box with iron powder, the iron bar, the plastic chips, and the compass.

So you can use these four items to check whether an object is a magnet — even when you can't tell by looking, because the magnet is hidden inside a plastic covering.

So how about the stand for the ring magnet? Is it a magnet or not?

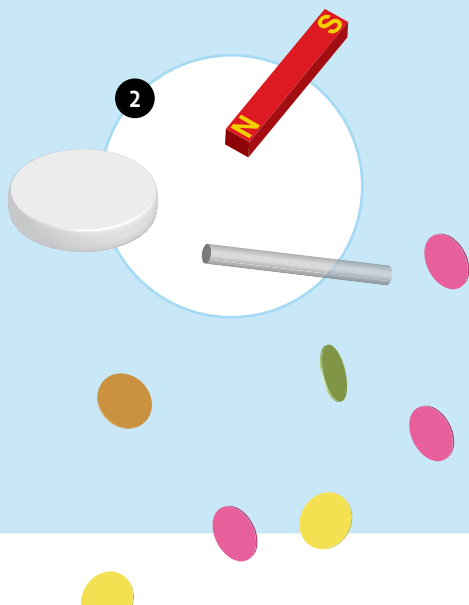
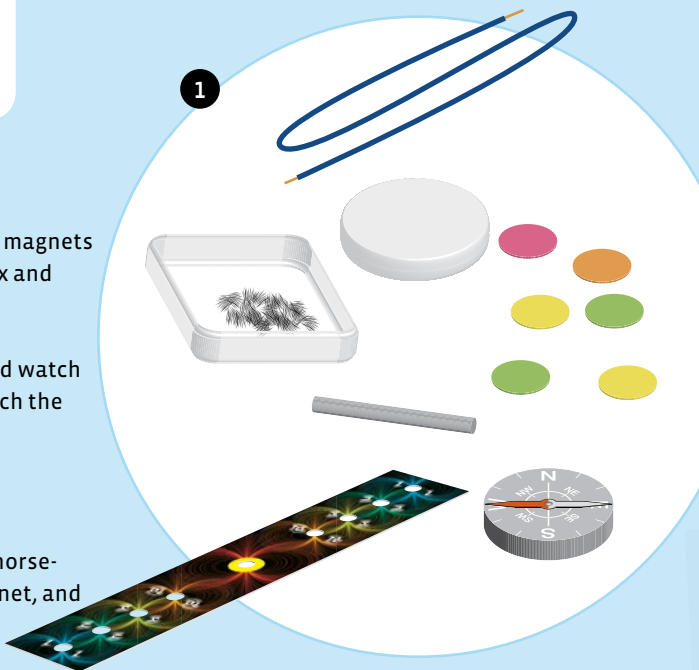

# Mutual attraction

## YOU WILL NEED

→ all of the magnets

## HERE'S HOW

1. Place two ball magnets a slight distance apart on the table.

*What do you notice?*

2. Try to pull the two ball magnets apart.

3. Repeat the experiment with all the other magnets.

*What do you notice?*

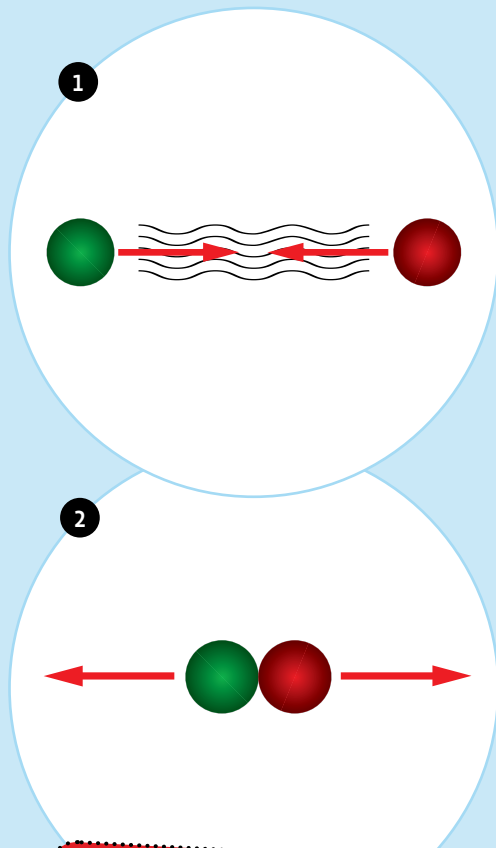

## TIP

Magnets influence and interfere with each other. So you should always place only those magnets on the table that you need at that moment.

Keep the other ones at least one meter away, so they don't interfere with the ones you're using.

## → WHAT'S HAPPENING?

Most magnets are hard to keep in one place. The ball magnets, in particular, roll toward each other and stick together. But the others seem to find each other attractive as well. They exert a mysterious pull on each other, and you really need to use some force to pull them apart again.

So magnets exert a mutual attraction on each other. Some will even flip around in the process.

# It all depends on the distance

## YOU WILL NEED

- horseshoe magnet
- block magnet
- iron rod

## HERE'S HOW

1. Move the iron rod towards the horseshoe magnet and note how strongly they stick together.
2. Now pull the rod away, gradually increase the distance between magnet and rod, and note the strength of the magnetic force at different distances.
3. Repeat the experiment with the block magnet.

What's the difference?

### → WHAT'S HAPPENING?

The force that magnets exert on each other is largely a factor of how far apart they are. The closer they are, the stronger the magnetic force that you'll feel. But as you move them farther apart, the force quickly grows weaker.

With the block magnet, you will feel a stronger force overall: It is somewhat more powerful than the horseshoe magnet.

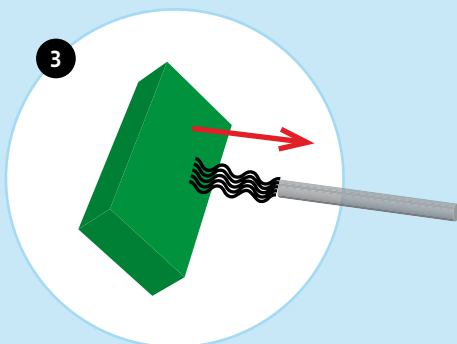
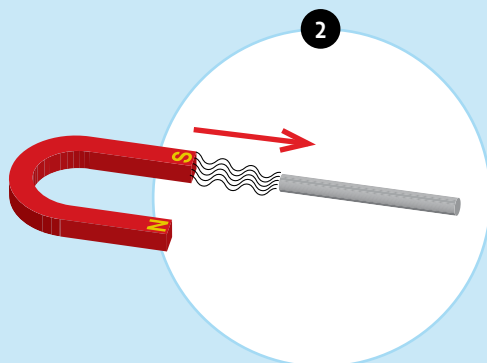
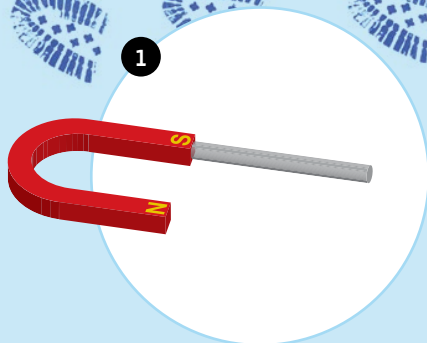



## Scientific expedition at home

### YOU WILL NEED

- horseshoe magnet
- various household items

**WARNING!** Make a wide detour around the TV, the computer (especially diskettes and magnetic media), video and music cassettes, and credit and debit cards: The magnet would destroy the data stored on them!

### HERE'S HOW

1. Walk around your house or apartment with the magnet, holding it up to various objects to see if it attracts them.
2. The following things would be good to investigate as you make your rounds: porcelain, glass, cardboard, paper, plastic, coins, furniture, cutlery, nails, needles, cooking pots, and paper clips.

1

2

### → WHAT'S HAPPENING?

You will notice that the magnet only attracts certain objects, while others don't seem interested in it at all. There's an explanation for that: Magnets only exert their force of attraction on things that are made of or that contain iron. That means that you can use the magnet to test whether there's any iron contained in an object.



# Iron turns into magnet

## YOU WILL NEED

- block magnet
- iron rod
- plastic chips

## HERE'S HOW

1. Lay the iron rod flat against the side of the block magnet, with its end projecting out beyond the magnet's edge.

2. Spread the plastic chips out on the table and pass the iron rod over them.

*What happens?*

3. Now separate the iron rod from the block magnet.

### → WHAT'S HAPPENING?

At first, the iron rod will attract one or more of the chips. So the magnet doesn't only attract the iron rod — it also makes the rod magnetic, so that the rod in turn attracts the iron rings around the plastic chips.

The chips will drop away from the iron rod, however, once you've removed it from the block magnet. The rod only acts like a magnet when it's connected to one.

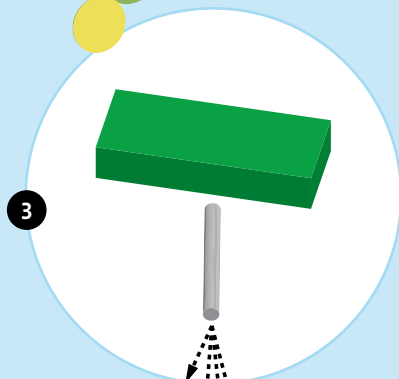
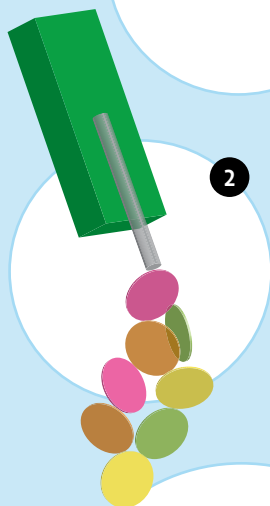
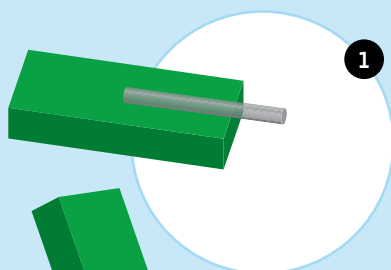

# A new magnet is born

## YOU WILL NEED

- block magnet
- iron rod
- compass
- long sewing needle

## HERE'S HOW

1. Place the needle against the compass.
  2. Do the same with the iron rod.
  3. Now stroke the iron rod 50 to 70 times across one of the large surfaces of the block magnet.
 

**Important!** Always stroke in the same direction across the same surface of the magnet.
  4. Now move the block magnet far away and move the iron rod close to the compass needle again.
  5. Now, stroke the sewing needle across the block magnet as you did in step 3, and look what happens when you hold the needle close to the compass.
- Keep the magnetized needle in a safe place — you'll need it again later.**

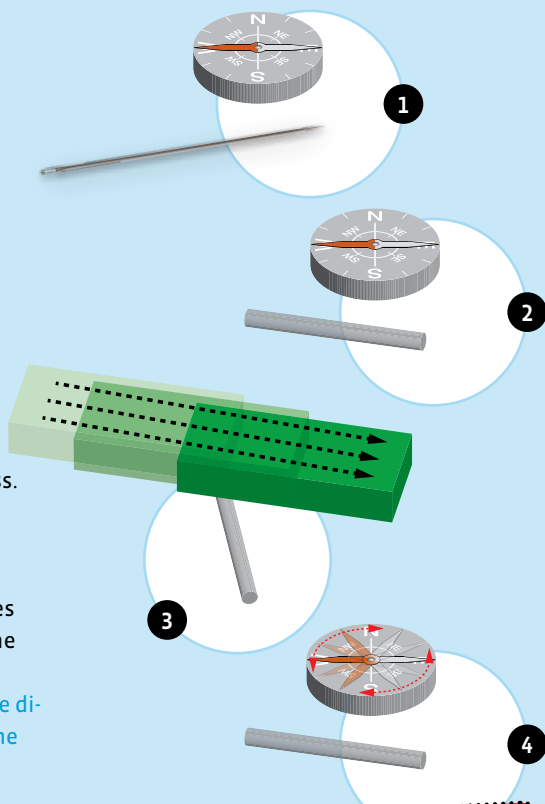

## → WHAT'S HAPPENING?

Without the “treatment” with the block magnet, the compass needle won’t react much to either the iron rod or the sewing needle (if it does, the sewing needle must already have had contact with a magnet). With the iron rod, still nothing happens after “treatment” with the magnet. The sewing needle, on the other hand, astonishingly retains its magnetic force — the compass needle reacts strongly to it. That is due to the fact that sewing needles are made of steel. Steel has the property of remaining magnetic after being stroked with a magnet.

# Penetrating force

## YOU WILL NEED

- block magnet
- iron rod
- *cardboard, paper, knife made of steel, plastic wrap, fabric, aluminum foil*
- ruler

## HERE'S HOW

1. Place the iron rod on a smooth table surface and see how close you can bring the block magnet before the rod starts to roll toward it. Make a note of the distance between magnet and rod when that happens.

2. Now slide a piece of cardboard in front of the block magnet.  
*Is there a difference now in the distance at which the rod starts to roll toward it?*

Test the other materials as well by sliding them in front of the block magnet.

### → WHAT'S HAPPENING?

The magnetic force penetrates almost all the materials without losing much of its strength at all. Only the steel knife is really effective at blocking it. That has to do with the fact that steel contains iron.

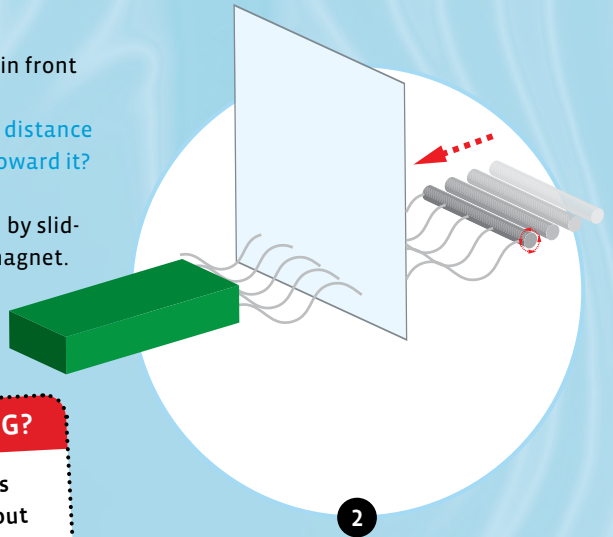
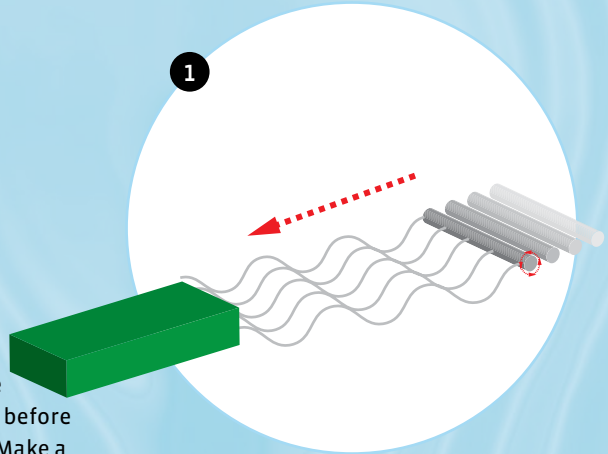

## Finding the force

### YOU WILL NEED

- horseshoe magnet
- block magnet
- bar magnet
- iron rod

### HERE'S HOW

1. Place the individual magnets far apart from one another on the table.  
*Where do you feel the strongest force of attraction?*

Now, probe the block magnet and bar magnet as well.

*What do you notice?*

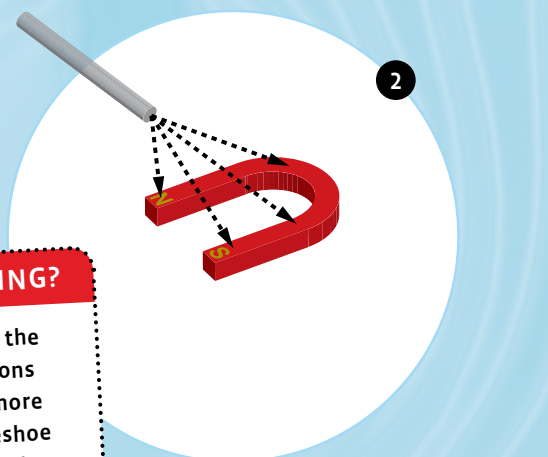
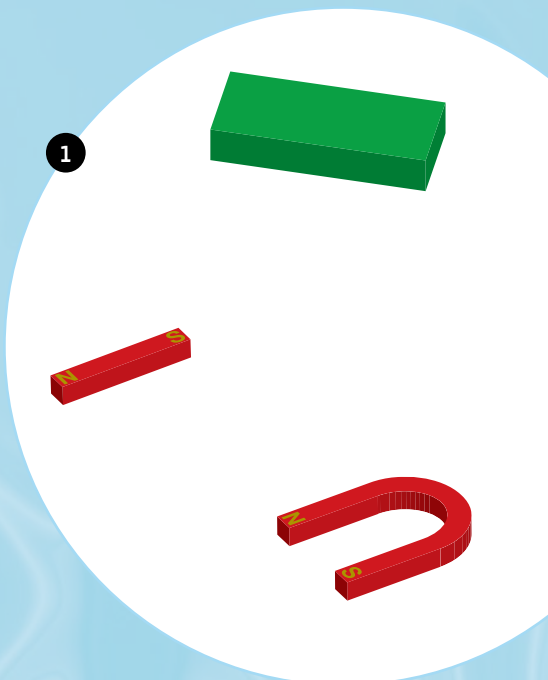

### → WHAT'S HAPPENING?

You will notice that each of the magnets has certain locations where it attracts the iron more powerfully. With the horseshoe and bar magnets, it's the ends that are the strongest, while with the block magnet it's the large surfaces. Not all parts of a magnet are uniformly powerful.

# Exploring the poles

# NORTH

## YOU WILL NEED

→ all the magnets

## HERE'S HOW

1. You will see the letters “N” and “S” at the two ends of the bar magnet. These ends are known as “poles.”
  2. Now approach one end of the horseshoe magnet with one end of the bar magnet. Then test the other end of the horseshoe magnet.
- Which ends attract each other, and which repel each other?*
3. Probe all sides of the block magnet with both ends of the bar magnet.
- What do you determine?*
4. Do the same thing with the ball magnets. Place them on a smooth surface for your investigation.

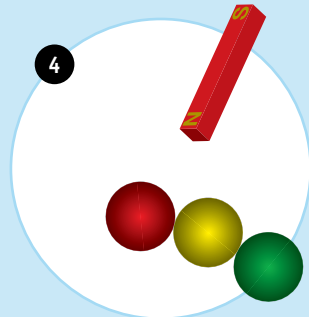
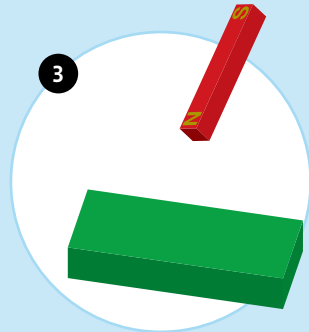
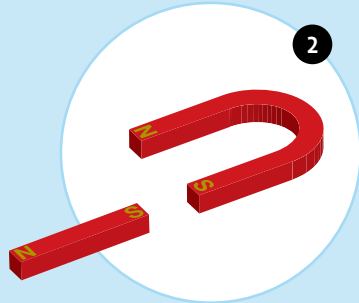
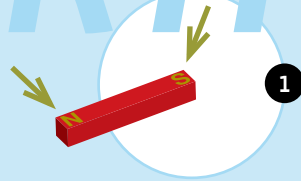

## → WHAT'S HAPPENING?

It's strange: Sometimes you can feel the expected force of attraction, but at other times the two magnets don't seem to want to get together at all — something pushes them apart. The ball magnets will even flip around, quick as a flash, in order to turn their attracting pole to the bar magnet. The two ends, or poles, apparently have different properties.

## Hidden poles

### YOU WILL NEED

- ball magnets
- bar magnet
- 2 different-colored permanent markers

### HERE'S HOW

1. Take two balls and let them roll freely on the table a slight distance apart. They will quickly click together.
  2. Pull them apart again, and mark the touching point (the point of contact) of one ball with one color, and that of the other ball with the other color.
  3. Let all of the balls click together in turn, and make your marks on them.  
*Important! Whenever you have used one color to mark one ball, be sure to use the other color to mark the other ball.*
  4. Use the bar magnet to test the marked locations.
- What do you notice?*

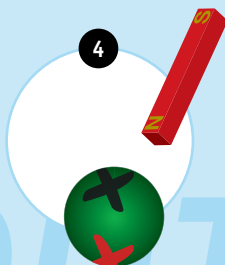
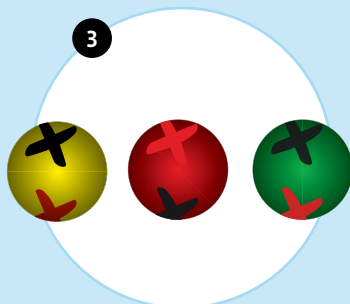
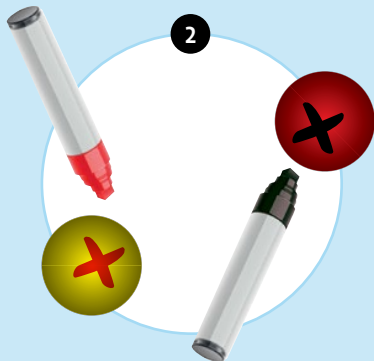
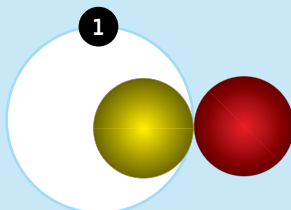

### → WHAT'S HAPPENING?

The markings reveal the truth — the balls have two poles too. No wonder, since each ball contains a tiny bar magnet inside its plastic cover.

SOUTH

# Jumping magnets

## YOU WILL NEED

→ 2 ring magnets

## HERE'S HOW

1. Place one ring magnet on the table.
2. Push the second ring magnet onto the first one with their two repelling sides facing each other. You will notice that it's not so easy to do without making the lower one scoot away.
3. When you finally manage to do it, quickly let go.

### → WHAT'S HAPPENING?

The magnet will really jump up into the air.

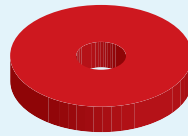

1

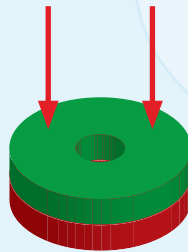

2

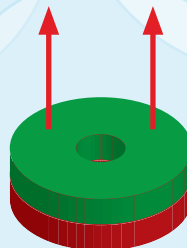

3



# Hovering magnets

## YOU WILL NEED

- all the ring magnets
- ring magnet stand

## HERE'S HOW

1. Stack the ring magnets one on top of one another on the stand. Be sure that all the repelling sides are facing each other, so all the magnets end up hovering in the air.

2. Push down on the top magnet a little.  
*What do you observe?*

3. Now carefully remove the top ring magnet.  
*What happens now?*

## → WHAT'S HAPPENING?

Even the very first ring magnet will hover freely a few centimeters up in the air. All of them will end up hovering above one another, as if held up by an invisible hand.

When you push down on the top ring, the lower ones will also shift down a little, even though there's no direct contact. Conversely, the lower ones will rise up a little when you remove the top ring magnet.

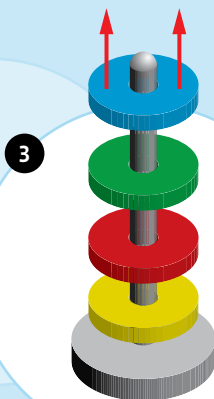
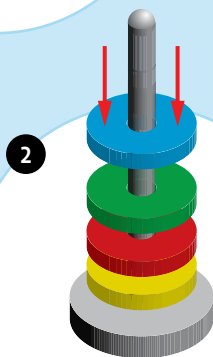
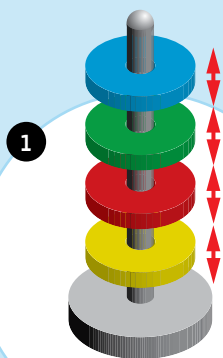

# Magical forces explained

## YOU WILL NEED

- all the ring magnets
- iron rod

## HERE'S HOW

1. Stack the four ring magnets with their attracting poles facing one another.
2. Carefully insert the iron rod through the hole in the center.
3. Holding the “ring tower” together tightly, tip it so that you’d think the iron rod would fall.

Does it fall?

### → WHAT'S HAPPENING?

When you start to insert the iron rod into the hole, you will feel a little resistance at first, but then the rod will practically get pulled inside. The rings hold it so tightly that even its own weight won't pull it out again. There's a powerful magnetic force inside the rings that holds the rod in place.

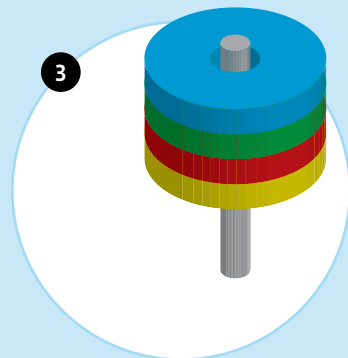
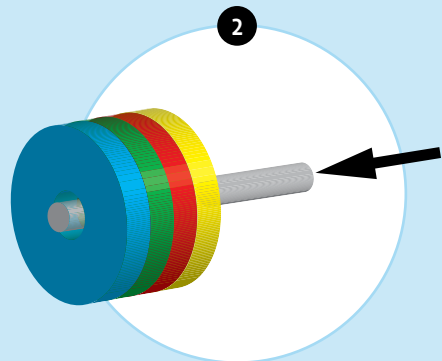
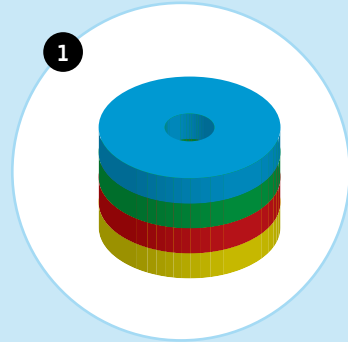

# Disappearing poles

## YOU WILL NEED

- bar magnet
- horseshoe magnet
- iron rod

## HERE'S HOW

1. Let your bar magnet stick to one end of the horseshoe magnet.
2. Now use the iron rod to test the magnetic force, particularly at the place where the poles meet.
3. Pull the magnets apart again. Now test all four ends with the iron rod.

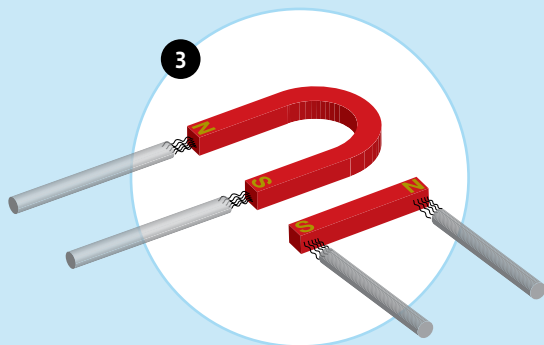
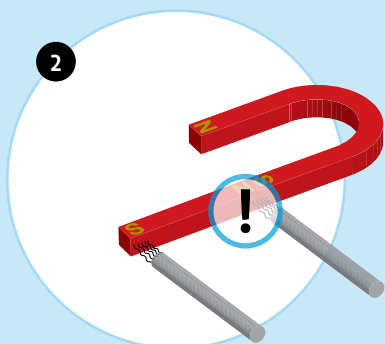
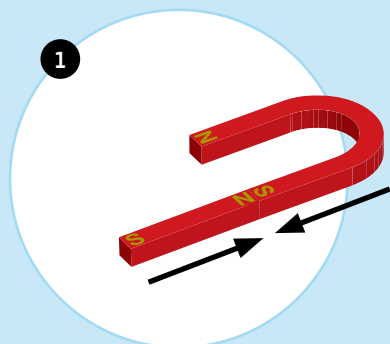

## → WHAT'S HAPPENING?

The horseshoe magnet and the bar magnet became one single magnet when they were stuck together. That's why you hardly detected any magnetic force at the place where they met. But the two outer poles were still there.

After the magnets are pulled apart again, the previously attached poles regain their former strength.

# MAGNETS

The magnets that people discovered thousands of years ago in nature were made of the mineral **magnetite**. This mineral, which forms grayish-brown crystals, is composed of iron and oxygen in a very specific ratio. Magnetite is created naturally through volcanic activity.

Today, magnets can be produced artificially from compounds of the metals iron, nickel, and aluminum. But there are also some magnets that contain no iron at all.

A lot of materials and material mixtures have been tested for their magnetic properties, and mixtures of relatively rare metals have been discovered that can make much stronger magnets than those found in nature. Those magnets don't just attract iron, but will also attract the rarer metals nickel and cobalt almost as strongly.

PERMANENT MAGNETS possess a magnetic force all on their own, and they retain it permanently. This experiment kit has numerous permanent magnets in different shapes, some with plastic coverings. These, too, are produced artificially, so they are stronger than natural magnetic rocks.



**PERMANENT MAGNETS** possess a magnetic force all on their own, and they retain it permanently. This experiment kit has numerous permanent magnets in different shapes, some with plastic coverings. These, too, are produced artificially, so they are stronger than natural magnetic rocks.



# POLES

The locations where a magnet's magnetic force is strongest are called its poles. Every magnet has two of them. In other locations, its magnetic force is much weaker.



One pole is called the south pole, while the other is known as the north pole. You will find the corresponding letters — **N** for **North pole** and **S** for **South pole** — written on the magnets.

## CHECK IT OUT



## BAR MAGNETS...

...are composed of a huge number of tiny magnets lined up in such a way that their magnetic effect is compounded. Iron also contains micro-magnets of this type, but they are all jumbled up together in a way that cancels out their individual magnetic forces. If a magnet touches the iron, it lines up the micro-magnets so that the iron also turns into a magnet, at least temporarily. As soon as you take the magnet away, though, disorganization quickly returns.

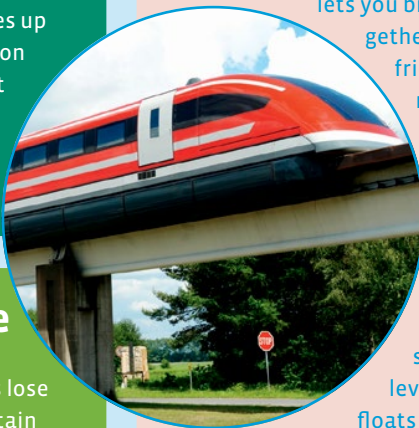

## MAGNETIC CUSHIONS:

Magnets can be stacked up with their repelling poles facing one another, as long as you make sure that they can't slip to the side. The advantage of this kind of magnetic cushion lies in the fact that it lets you bring objects together in a practically friction-free manner.

Magnets of this kind are used for sensitive technical instruments. The "Transrapid" magnetic levitation train also

floats on a magnetic cushion, which enables it to reach speeds of up to 500 kilometers per hour without making very much noise at all.

## Curie temperature

Iron, steel, and related materials lose their magnetic property at a certain temperature. This temperature is known as the Curie temperature after its discoverer, the French physicist Pierre Curie. Each material has its own unique Curie temperature. For pure iron, it is 766 degrees Celsius. If you heat iron above that point, it will no longer be attracted by a magnet, although it will regain its magnetism once you let it cool down below that temperature again.



### Note!

Unlike poles attract each other. Like poles repel each other.



A young child is holding a small, round, brass compass over their eyes, looking through it. The background is a textured, aged map with various colors and markings, suggesting a historical or nautical theme.

# Compass

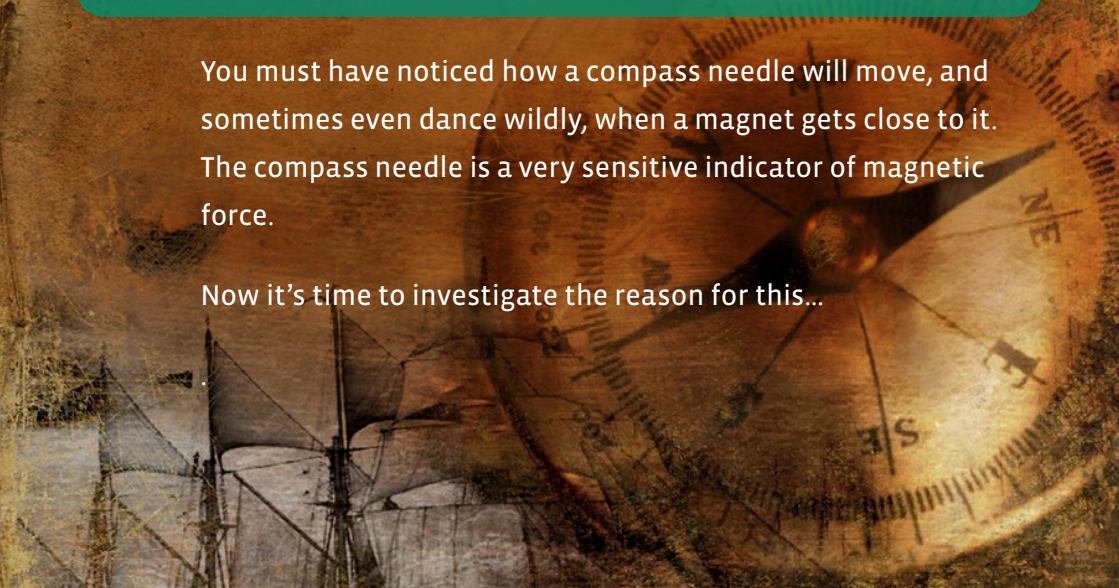
A large, detailed compass rose is shown, with the cardinal directions labeled: N (North), NE (Northeast), E (East), SE (Southeast), S (South), SW (Southwest), W (West), and NW (Northwest). The compass is set against a textured, aged background.

You must have noticed how a compass needle will move, and sometimes even dance wildly, when a magnet gets close to it. The compass needle is a very sensitive indicator of magnetic force.

A large, multi-masted sailing ship is shown on the sea, with its sails partially set. The ship is detailed with rigging and masts, and is set against a textured, aged background.

Now it's time to investigate the reason for this...

# Bloodhound for magnets

## YOU WILL NEED

- all the magnets
- compass
- iron rod

## HERE'S HOW

1. Place the compass on the table in such a way that its needle can move freely.

Set the iron rod against the block magnet and position all the magnets as far away from the compass as possible.

2. Move the block magnet near the compass. Then, test all the other magnets as well.
3. Now move the iron rod, which had been lying alongside the block magnet, toward the compass.

## → WHAT'S HAPPENING?

Even when the magnet is pretty far away, the needle moves and points to it. It can even sense relatively weak magnetic forces. Thanks to its high mobility — it is mounted on a thin support in such a way that it moves very easily — it reveals these forces quite clearly.

It even reacts readily to the iron rod, which isn't actually a magnet. After being placed together with the powerful block magnet, though, the rod retains a trace of magnetism within itself.

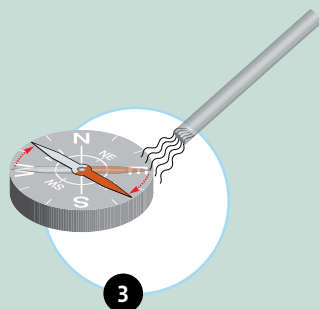
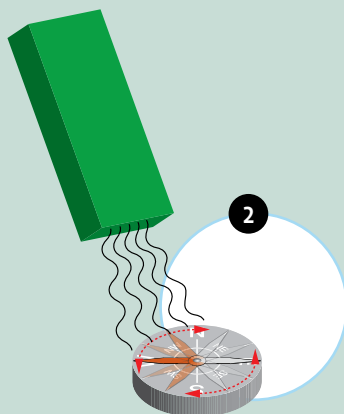
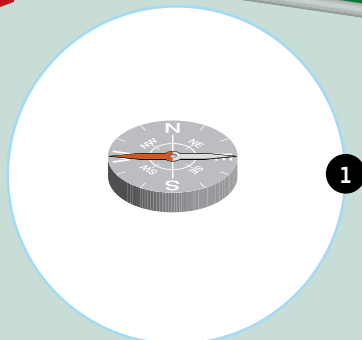
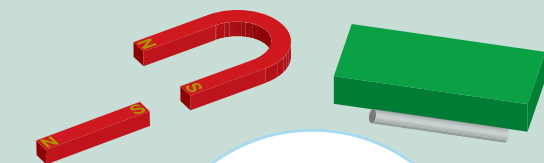

# The needle points to the pole

## YOU WILL NEED

- all the magnets
- compass

## HERE'S HOW

1. Place the compass on the table in such a way that its needle can move freely.
2. Now hold the bar magnet close to the compass and pay special attention to which end of the needle points toward the magnet.
3. Now, turn the magnet around.
4. Perform the experiment with the other magnets as well. Hold the horseshoe magnet so that first the north pole and then the south pole is closer to the needle.

### → WHAT'S HAPPENING?

The compass needle recognizes which pole is turned toward it. If it's the south pole, it turns its red end toward the magnet; if it's the north pole, it's the white end.

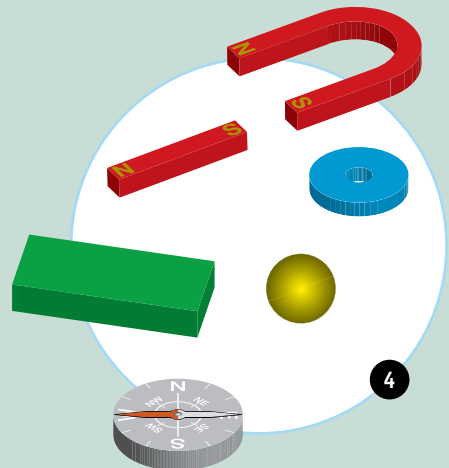
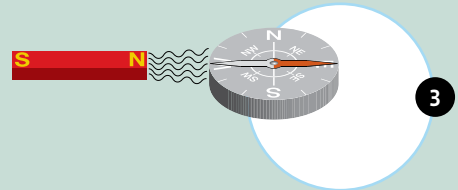
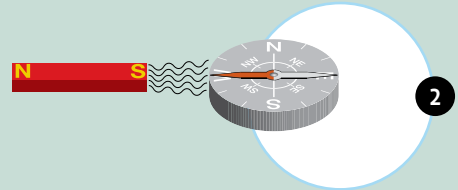
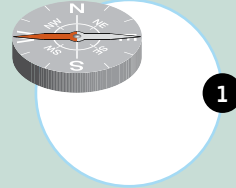



# Magnet on a string

## YOU WILL NEED

- all the magnets
- *string*
- *scissors*

## HERE'S HOW

1. Tie a piece of string to the horseshoe magnet and hold the string so that both poles of the magnet are pointed down.
2. Now bring the bar magnet toward the horseshoe magnet, and move it so that first one pole is pointed toward the horseshoe magnet and then the other pole.

Also try the same thing with the other magnets.

### → WHAT'S HAPPENING?

While it's hanging from the string, the horseshoe magnet responds by turning like a compass needle. That shows that the compass needle is also a magnet.

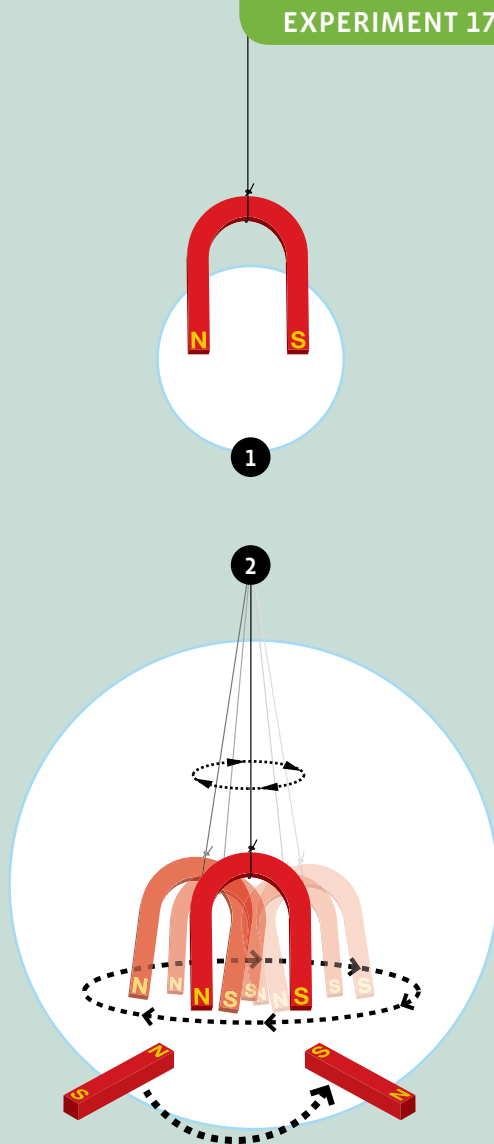

# The sewing needle shows the direction

## YOU WILL NEED

- polystyrene disk
- bar magnet
- compass
- *tape*
- *magnetic needle from Experiment 6*
- *bowl*
- *water*

## HERE'S HOW

1. Tape the needle to the center of the polystyrene disk. Fill the bowl with water and float the disk on the water. Be careful not to let the disk touch the sides of the bowl.
2. Now move first the north pole and then the south pole of the bar magnet toward the needle, and note when the pointed tip and when the eye of the needle is attracted.
3. Then place the bar magnet far away and pay attention to the direction the needle points after a few minutes.
4. **Where does the needle point when the disk stops moving?**

Compare its position with that of the compass needle.

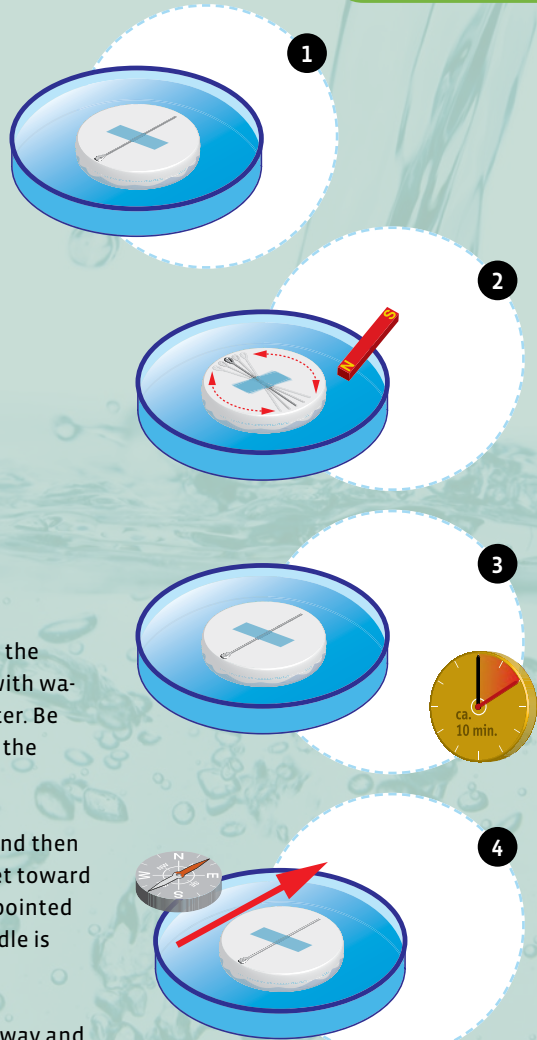

## → WHAT'S HAPPENING?

The needle always turns to point in the same direction — even if you turn the polystyrene disk to point the needle in a different direction. It's the same direction that the compass needle points. So you have built yourself a simple compass.



# Still got it.

Despite the existence of satellite navigation systems, the magnetic compass is still in use. **GPS** (Global Position Systems) can augment navigation with map and compass, but by no means replace it.

In addition to its independence from any energy supply or electronics, determining your heading with a compass is a lot faster and more precise than using a GPS device.

## The compass needle...

...is a magnet mounted in a way that lets it move easily. Its red end is the north pole, as you can see from the fact that it is attracted to the south pole of the bar magnet. So its white end must be the south pole.

Apart from the traditional needle shape, the pointer can also take the shape of a complete disk or, in a ship's compass, even the shape of a ball. Around the needle, you usually find an angle scale with compass points indicating cardinal directions such as north and south. You can rotate this scale so that the north pole of the compass needle actually points to "N" (north). That way, it's easy to see exactly where the other directions lie.



## History

The compass is one of those inventions whose original creator is lost in the mists of time. Around 100 AD, the Chinese had a magnetic ladle with a handle that always pointed to the south. But it wasn't until 900 years later that they used a compass needle to find their direction on the sea.

In Europe, the ship's compass with needle and compass rose was only introduced about 600 years ago — with far-reaching consequences. This is what enabled brave European seafarers to venture out onto the open ocean. The age of exploration had begun, and Christopher Columbus crossed the Atlantic and sailed to America.



A young boy with freckles is shown from the chest up, holding a blue-handled magnet. The background features a large, dark, textured object, possibly a magnet, with intricate iron powder patterns. A purple semi-transparent box is overlaid on the image, containing the title text.

# Magnetic Force and Magnetic Fields

You've probably been asking yourself what the iron powder in the plastic box is for. You will be amazed. You can use the powder to make a magnet's force visible, since the powder accumulates wherever the magnetic force is strongest.

What's going on with the pretty iron powder patterns, what do their lines of force mean, and what do those lines have to do with Earth? You will learn about all these things and more in this chapter.

## Hidden forces made visible

### YOU WILL NEED

- bar magnet
- block magnet
- ball magnet
- ring magnet
- horseshoe magnet
- box with iron powder

### HERE'S HOW

1. Take all the magnets in turn and hold them under the box with the iron powder.

What do you observe? Can you recognize different patterns?

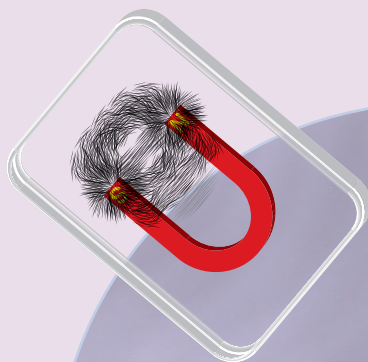

### → WHAT'S HAPPENING?

The different magnets produce different iron powder patterns. You can use the iron powder to render the magnetic force visible. At the poles, which is where the magnetic force is strongest, the fine iron filings will even stand erect. You can see that particularly clearly with the bar magnet and the horseshoe magnet. Since the block magnet has the strongest magnetic force, you can even use it to move the powder back and forth inside the box.

# Who is stronger?

## YOU WILL NEED

- all the magnets
- compass
- polystyrene disk
- ruler

## HERE'S HOW

1. Set the compass on the polystyrene disk. Place a bar magnet a few centimeters away, with its north pole pointing to the left side of the compass.
2. Now use the horseshoe magnet to check which side of the block magnet is the north pole.
3. Hold the bar magnet tight, and approach the compass with the block magnet from the top until the compass needle points in the middle between the two. It takes a little skill to get the two magnets in just the right position.
4. Exchange the block magnet for each of the other magnets in turn.

### → WHAT'S HAPPENING?

The needle has to decide which magnet it's going to point toward. The greater the distance from which the top magnet pulls the needle away from the bar magnet, the greater the force of the magnet you're testing. You can use this experimental setup as an easy way to compare the strengths of different magnets.

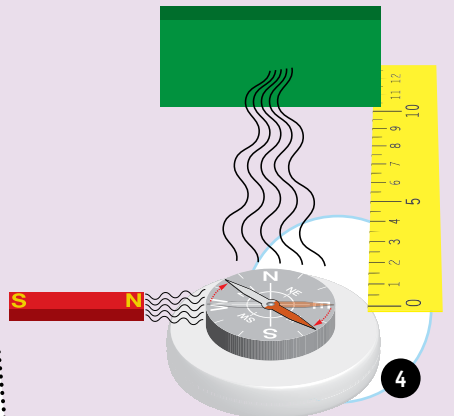
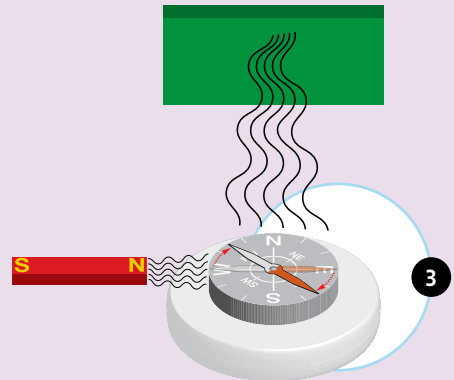
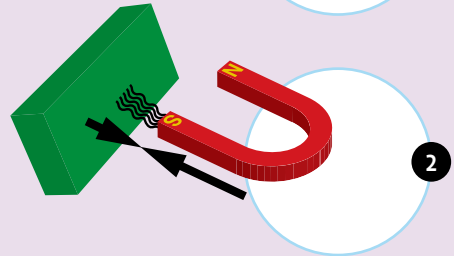
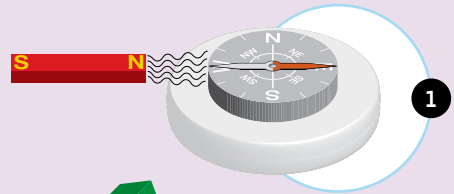

# Adding and subtracting forces

## YOU WILL NEED

- bar magnet
- 2 ball magnets
- 2 ring magnets
- polystyrene disk
- compass

## HERE'S HOW

1. Set the compass on the polystyrene disk and position the bar magnet as in Experiment 20.
2. Look for the north pole of the ball magnet. Hold the ball magnet at the distance that will make the compass needle remain halfway between the two magnets again.

Continued on the next page

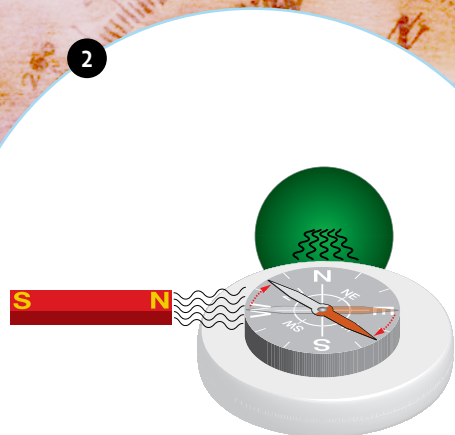
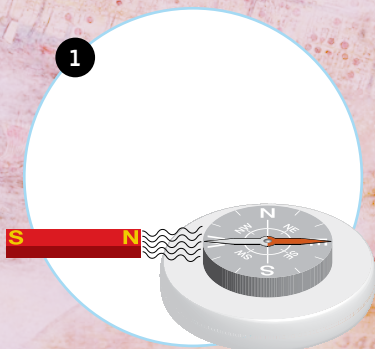

# Adding and subtracting forces

## HERE'S HOW IT CONTINUES

3. Now hold the ball tight and let the second ball magnet click to the first one, so they stick together by magnetic attraction.

Where does the needle move?

4. You will have to move the two balls apart a little before the needle returns to its previous position.

5. Now take the two ring magnets.

What happens when the second ring magnet turns its repelling pole toward the first ring magnet?

(You will have to hold the two magnets tightly together to try this!)

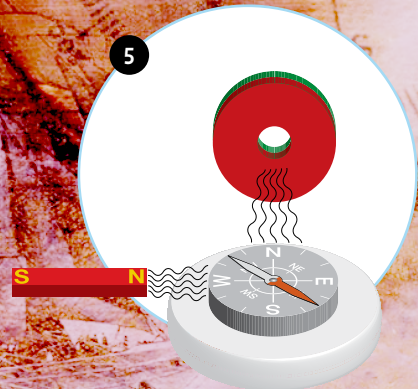
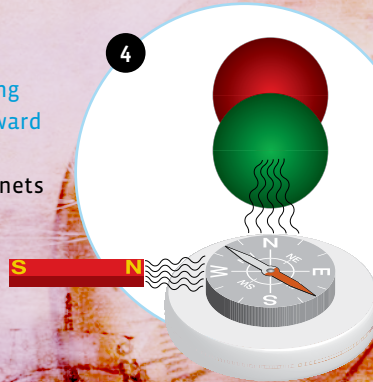
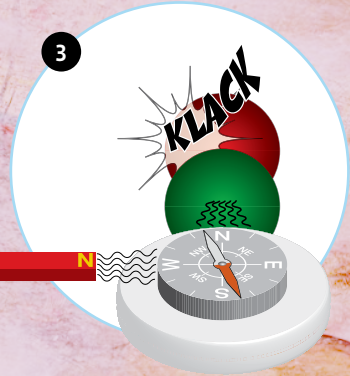

## → WHAT'S HAPPENING?

Magnets can intensify one another's strength when their mutually attracting poles are joined together. The two ball or ring magnets are stronger together than either one on its own. But if their mutually repelling poles meet, that reduces their strength quite a bit. Apparently, the two poles' forces cancel each other out to some extent.



# Muted magnetic force

## YOU WILL NEED

- bar magnet
- horseshoe magnet
- compass
- iron rod

## HERE'S HOW

1. Set the bar magnet a little distance away from the compass.
2. Push the horseshoe magnet toward the compass from the top, and adjust the distance between magnets and compass so that the compass needle is in the middle again.
3. What happens to the compass needle when you slide the iron rod in front of the horseshoe magnet?

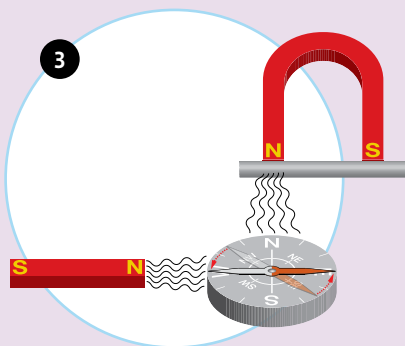
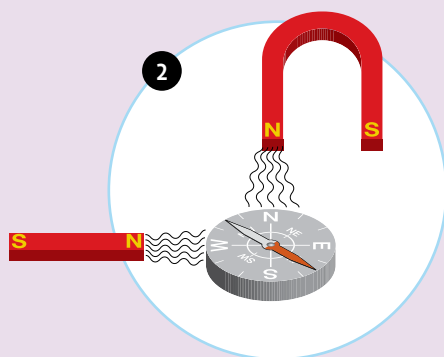
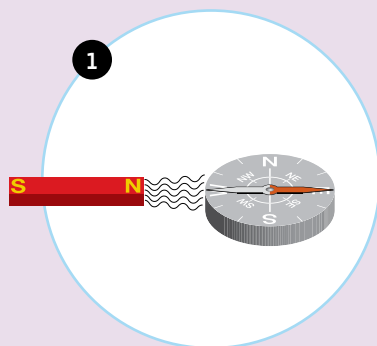

### → WHAT'S HAPPENING?

Apparently, the magnet is so fond of the iron rod that less of its magnetic force spreads out from it — therefore, its effect is weaker.

So when a piece of iron is attached to the poles of a magnet, it appears much weaker from the outside than when its poles are free.

# Compass needle as bloodhound

## YOU WILL NEED

- bar magnet
- compass

## HERE'S HOW

1. Place the bar magnet on the table and start by moving the compass very slowly around it in a tight circle.
2. Then continue moving it around the compass in larger and larger circles. Keep your eye on where the needle is pointing as you do this.

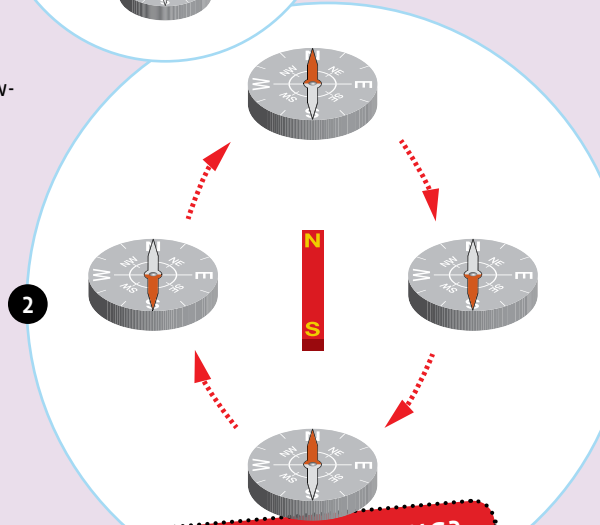
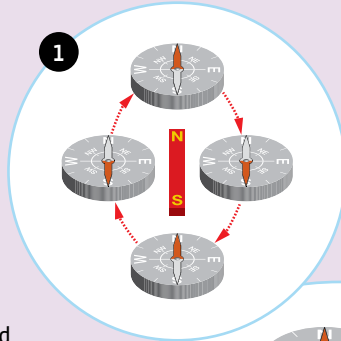

### → WHAT'S HAPPENING?

With each round, the needle behaves according to the same principle. It acts as if the magnet were surrounded by lots of lines coming out of one pole, which pass through the space around it and then return back to the other pole. These lines are known as magnetic lines of force.

A magnet, such as the compass needle, will always try to orient itself such that it is aligned with these lines of force.



## Lines of force made visible

### YOU WILL NEED

- all the magnets
- box with iron powder

### HERE'S HOW

1. Place the box with iron powder on top of each of the magnets in turn, as you did in Experiment 19.
2. This time, though, pay special attention to the patterns that form after shaking and knocking the box holding the iron powder. Keep the magnet pressed tightly against the box as you do this. You may have to try it a few times before you get a pretty pattern.

### → WHAT'S HAPPENING?

In a magnetic field, each individual iron particle turns into a tiny magnet that behaves similarly to a compass needle. These magnets stick together by their mutually attracting poles, and form chains in the magnetic field running parallel to the lines of force.

These chains are particularly easy to see with the horseshoe magnet, running in the shape of an arch from one pole to the other. With the other magnets, especially the block magnet, you can clearly see how the lines of force emerge from the poles.

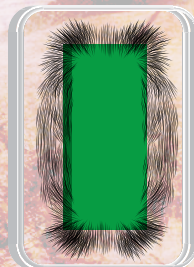

# The magnetic force of Earth

## YOU WILL NEED

- all the magnets
- polystyrene disk
- compass
- *bowl*
- *saucer*
- *water*
- *magnetized needle from Experiment 6*

## HERE'S HOW

1. Fill a bowl with water as you did in Experiment 28, place the bar magnet on the polystyrene disk, and let the disk float in the bowl. Check the orientation of the magnet with the compass.

Carry out this experiment with the other magnets as well. If they are too heavy for the polystyrene disk, simply use another floating base, such as a saucer.

## → WHAT'S HAPPENING?

The bar magnet quickly turns so that the end marked with an "N" is pointing to the north, while the other end points to the south. The other magnets, and of course your magnetized needle as well, also orient themselves in a north-south direction in response to a magnetic field covering Earth.

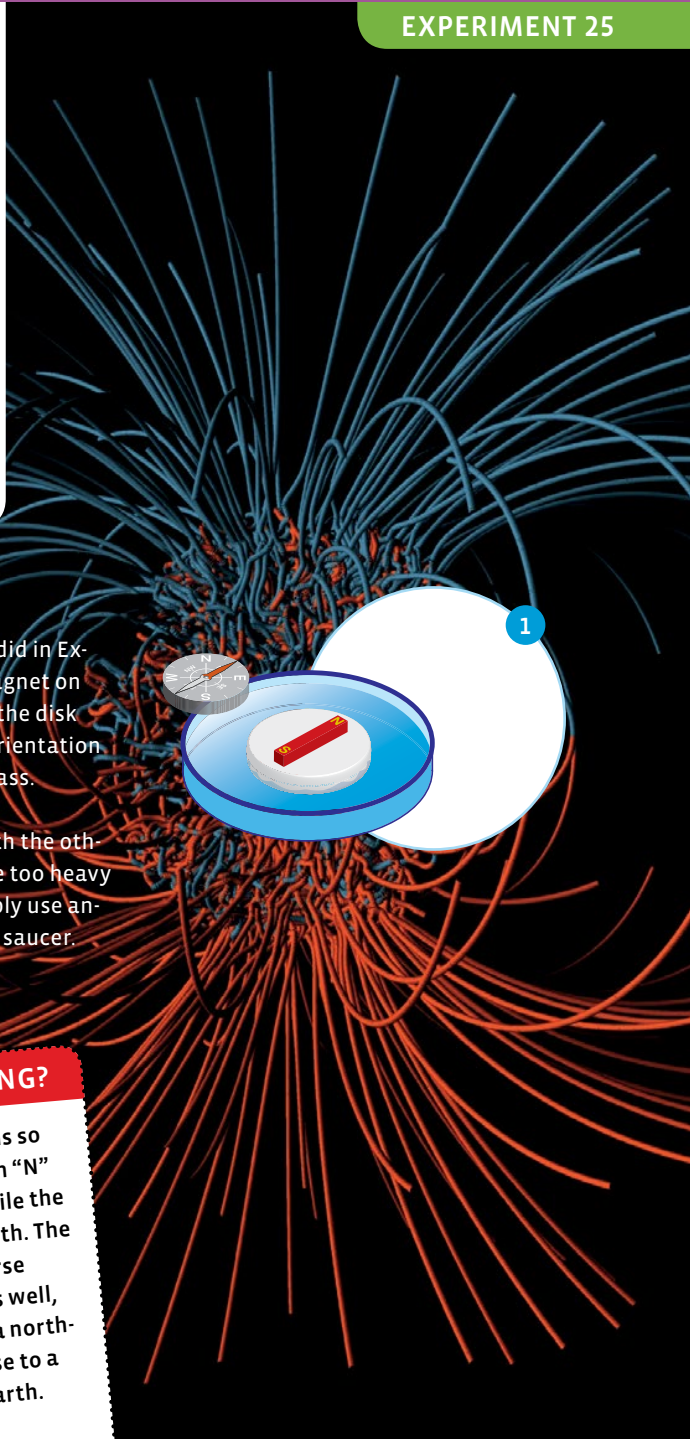

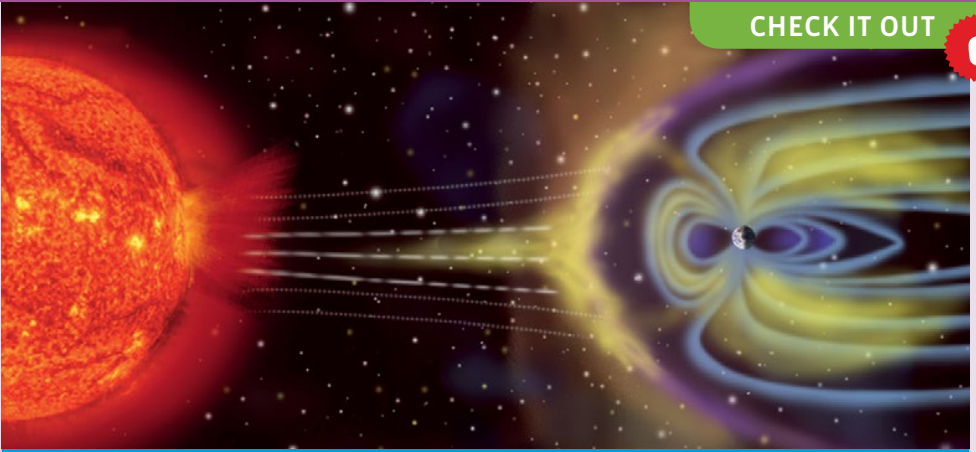

# EARTH'S MAGNETIC FIELD

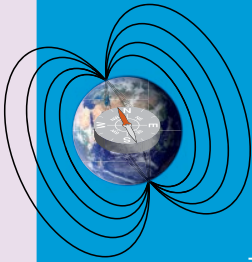

For centuries, it was a complete mystery why a magnetic needle pointed to the north or south. Scientists rightly asked what the rotation of Earth might have to do with magnetism. Were there, for example, gigantic magnetic mountains at Earth's poles? Or might the North Star, which could be seen above the North Pole, be responsible?

Today we know that Earth acts as if there were a giant bar magnet hidden inside it. But Earth's magnetic poles don't exactly match the rotational poles. Instead, they are a few thousand kilometers away. Between these magnetic poles, there is a powerful magnetic field stretching across the entire globe. This is what your magnets and all magnetic compasses react to. Earth's magnetic field isn't actually produced by a permanent magnet, but by enormous electric currents circulating deep beneath the surface in its metallic core.



**MAGNETIC MOUNTAINS** → In fact, you can't detect any particularly strong magnetic field at Earth's magnetic poles. And there's nothing very unusual about the landscape there. The supposed magnetic mountains — in the Middle Ages, people believed in the existence of a magnetic mountain that could pull the iron nails out of ships that passed by it — belong to the realm of fairy tales. What is interesting is that the magnetic field's lines of force enter the magnetic poles in a vertical direction, so the needle of an appropriately designed compass will point straight down.

## MAGNETIC FIELD

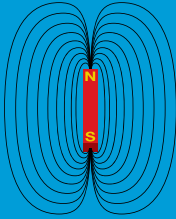

The lines depicted here are just a model. But you can picture a magnet as producing a countless number of lines arranged tightly together. This invisible force of a magnet is known as its **magnetic field**.

We can neither see nor feel a magnetic field, but iron and other magnets will react to it by being attracted, repelled, or rotated.

The field is especially strong close to the poles, but as you move away from the magnet it quickly gets weaker.

### Note

The lines stretching from pole to pole are called **magnetic lines of force**.



## CHECK IT OUT

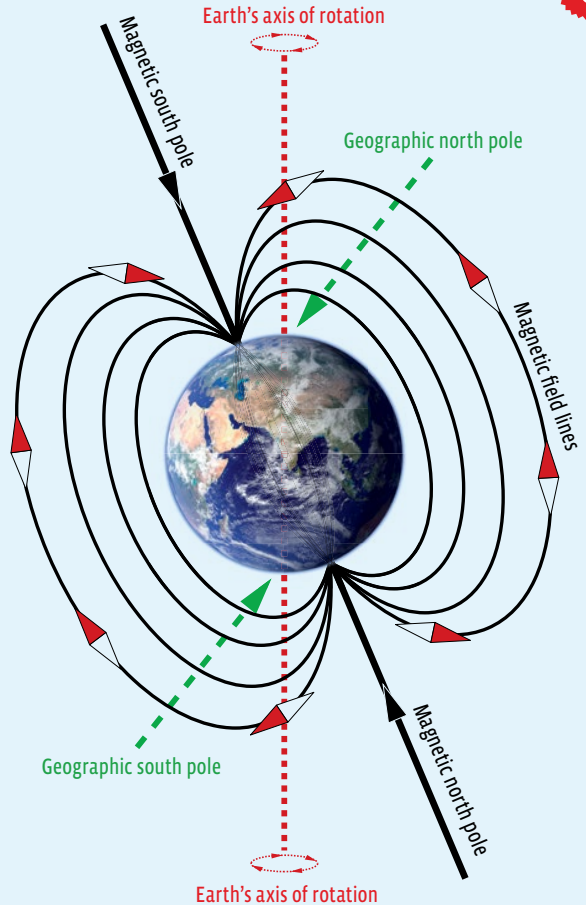

**WHICH POLE IS NORTH?** → This is how you can picture Earth's magnetic field. Compass needles orient themselves relative to the magnetic lines of force and thus point in a north-south direction. And in the drawing above, the artists didn't make an error in putting the magnetic south pole next to the geographic north pole! The compass needle, remember, is a little magnet. The end pointing to Earth's north pole has long been called the north magnetic pole. That applies to all magnets — even your bar magnet will rotate such that the N side is turned toward the north. But since, as you know, north and south poles always attract each other, the magnetic pole near the geographic north pole is logically a magnetic south pole.

Do electric current and magnets have something in common? As you know, a compass needle reacts to magnetic fields. Will it also react to electricity? You can use the wire included in the kit to assemble a small electromagnet, with its magnetic force supplied by electric current. Then you can test its powers...

# Electro- magnetism



# Magnetism from electricity

## YOU WILL NEED

- wire
- compass
- 1.5-volt battery
- scissors
- tape
- sheet of letter-size paper

## HERE'S HOW

1. Place the compass on the paper and wait for the needle to orient itself.
2. Guide the wire across the compass in such a way that it runs parallel to the needle. Secure it in this position with tape.
3. Hold the ends of the wire by their plastic insulation and briefly touch their exposed parts to the battery contacts. Watch the compass needle as you do this.

**CAUTION!** Only connect the wire to the battery very briefly, for just about one second. The powerful current will heat up the wire and the battery. You could burn yourself with the hot wire, and the battery could get damaged by the heat or quickly run out.

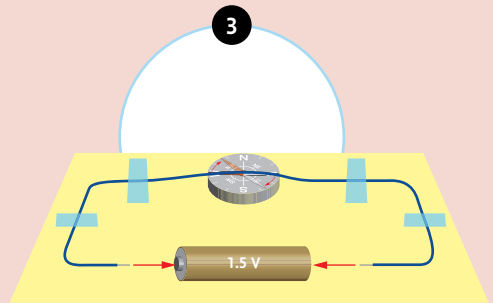
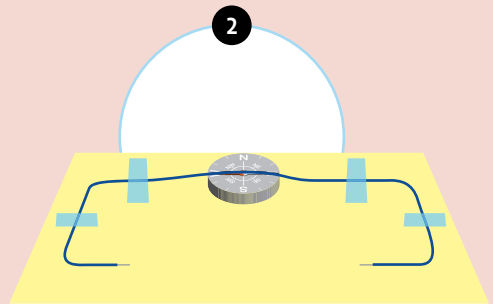
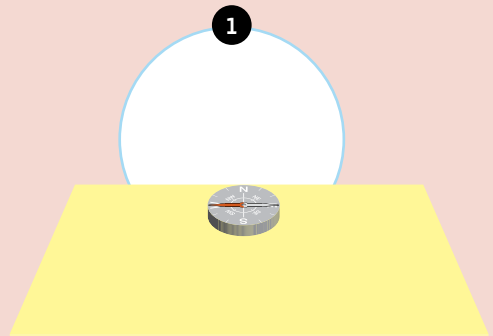

### → WHAT'S HAPPENING?

As soon as the electricity starts to flow through the wire, the compass needle jerks to the side.



# Electromagnet with intensified effect

## YOU WILL NEED

- wire
- compass
- horseshoe magnet
- 1.5-volt battery (AA)
- scissors
- tape
- sheet of letter-size paper

## HERE'S HOW

1. Wrap the center part of the wire five times around one arm of the horseshoe magnet and carefully pull the magnet out of the coil of wire.
2. Position the coil above the compass. Tape the wire to the paper as shown in the illustration. Then, as you did in the last experiment, tap the wire ends against the battery terminals. Keep your eye on the needle.

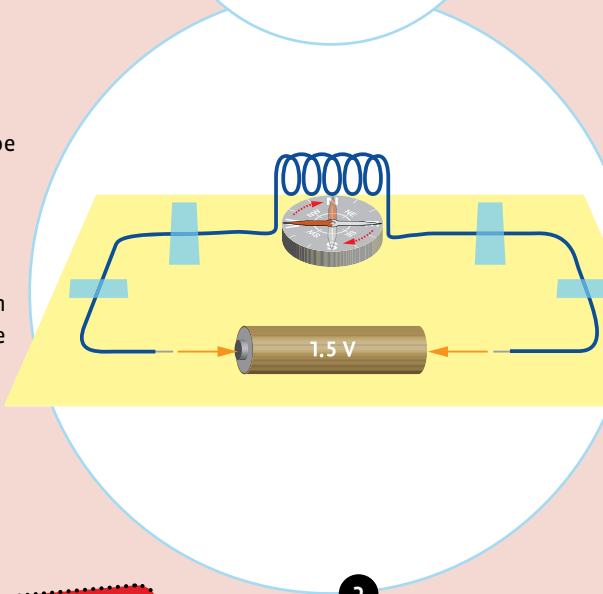
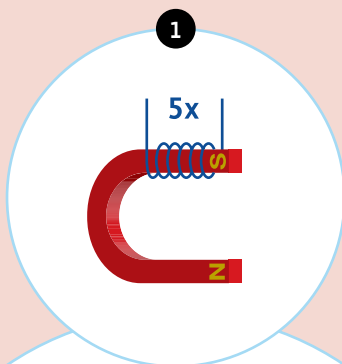

### → WHAT'S HAPPENING?

The needle really moves this time. The more wire you have next to it, the more dramatically it jerks to the side. The coil, with its larger quantity of wire, seems to intensify the effect of the electromagnet.

# Intensifying the magnetic force even more

## YOU WILL NEED

- iron rod
- wire
- compass
- 1.5-volt battery (AA)
- tape
- sheet of letter-size paper

## HERE'S HOW

1. Disassemble the wire again and create a narrow coil out of it by winding it about 15 times around the iron rod.
2. Tape the coil to the paper and set the compass in front of it. Let the current flow briefly.  
*How does the compass react?*
3. Now push the iron rod into the coil and briefly let the current flow again.

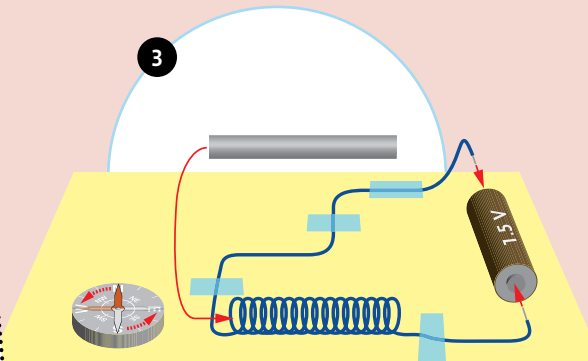
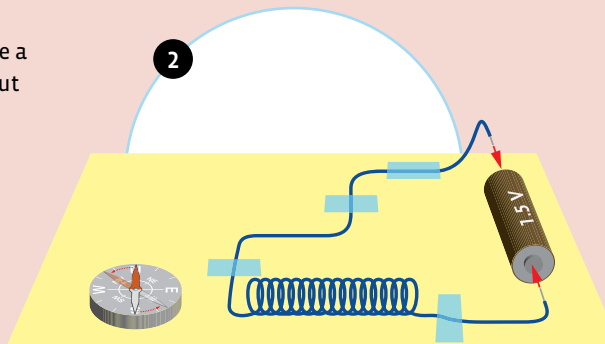
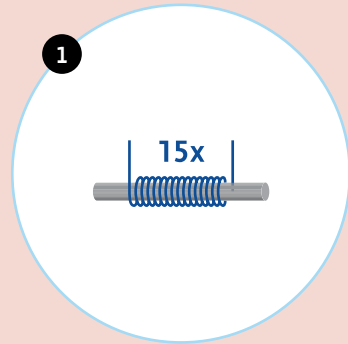

## → WHAT'S HAPPENING?

At first, the needle doesn't react particularly strongly — after all, most of the wire is still pretty far away from it. The iron core intensifies the power of the electromagnet quite a bit, though. Now, even with a considerable distance between coil and compass, the needle reacts very strongly.

# Exchanging poles

## YOU WILL NEED

→ setup from Experiment 28

## HERE'S HOW

1. Repeat the last experiment. Pay attention to which end of the compass needle points to the coil.

2. Then place the compass at the other end of the coil, and briefly switch on the current.

*Which end of the compass needle points to the coil now?*

3. Repeat this experiment, but first reverse the battery terminals so the current flows the opposite direction through the wire.

*What are the positions of the needle this time?*

### → WHAT'S HAPPENING?

The current flow really does transform the coil into a magnet, and this electromagnet has a north and a south pole just like a bar magnet — as the compass needle clearly shows. And when the current flows the opposite direction through the coil, the magnetic poles of the electromagnet switch as well.

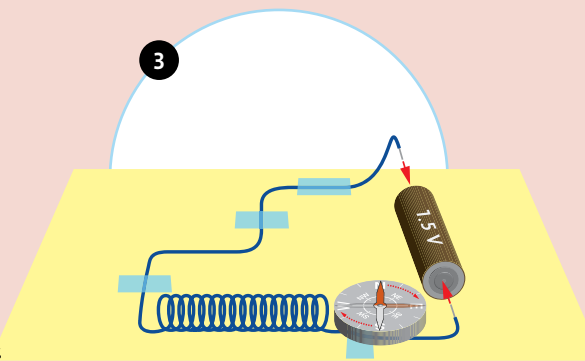
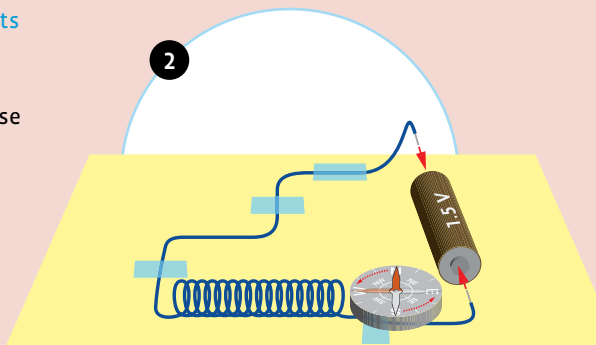
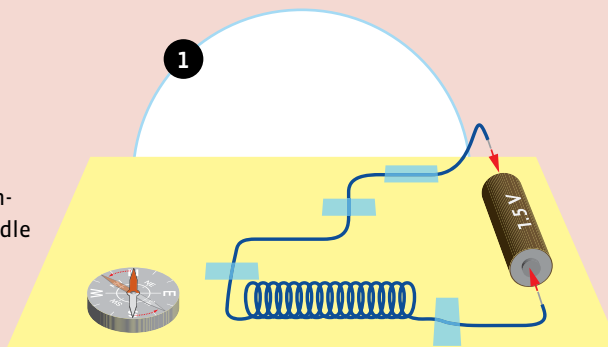

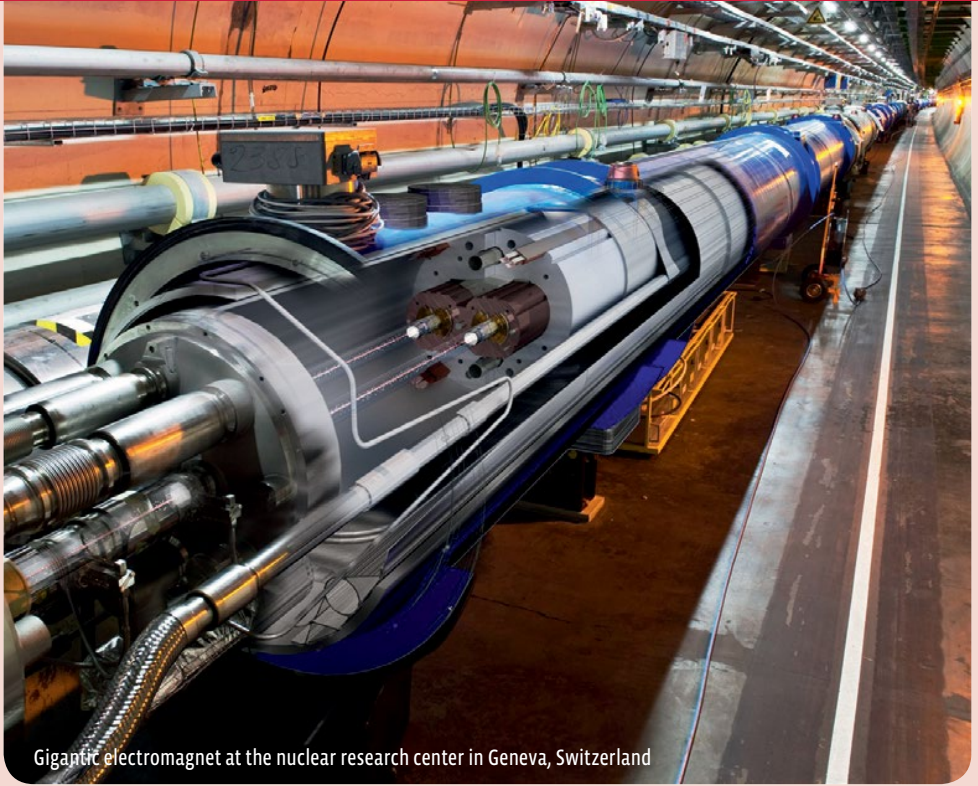

Gigantic electromagnet at the nuclear research center in Geneva, Switzerland

# Electromagnetism

The relationship between magnetism and electricity was first discovered around 1820, using the very same experiment with wire and compass that you tried on page 39. Scientists, who had previously thought of these two things as being completely different, were highly surprised. But there had already been a few clues before then. People had often noticed that a compass needle could become reversed after lightning struck a ship. Today we know that the lightning's powerful magnetic field reversed its magnetization..

# E



**ELECTROMAGNETS** → have lots of technical and industrial uses — namely, wherever particularly powerful magnets are needed. Recyclers, for example, use electromagnets attached to cranes to lift heavy pieces of iron. To let them go, all they need to do is turn off

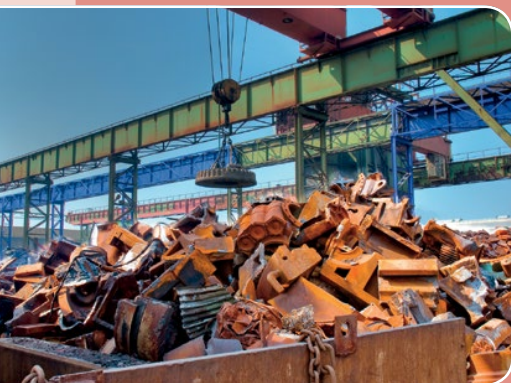

the current. Electromagnets are also used in speakers, electric motors, and power plant generators. One of the world's largest electromagnets is found at the European Organization for Nuclear Research lab in Geneva, Switzerland, with a core made of 64,000 metric tons of steel. (photo on p. 42)

## Galvanometers

A coil of wire wound around a compass (along with more coils of a thinner wire) is called a galvanometer, a device long used as a sensitive gauge for electric current.

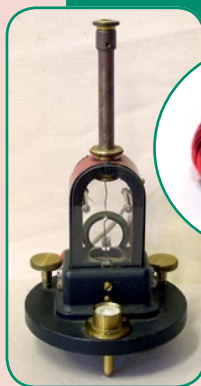

← Historic mirror galvanometer



## ELECTROMAGNETS

are only magnetic as long as current is flowing through them.

When that happens, it creates a magnetic field around the wire. When you turn off the flow of current, the magnetic field disappears — so electromagnets can be switched on and off.



# GAMES

## with Magnets

You can take advantage of magnetic effects to play some fun games. A little patience, speed, or skill may be needed. Fishing with magnets is a classic game, played for decades by children in many parts of the world.

It's most fun if you play the games together with a friend, so you can teach them everything you know about magnets.

## Every ball in its place

### YOU WILL NEED

- all the ball magnets
- multicolored paper strip
- *paper*
- *pen*

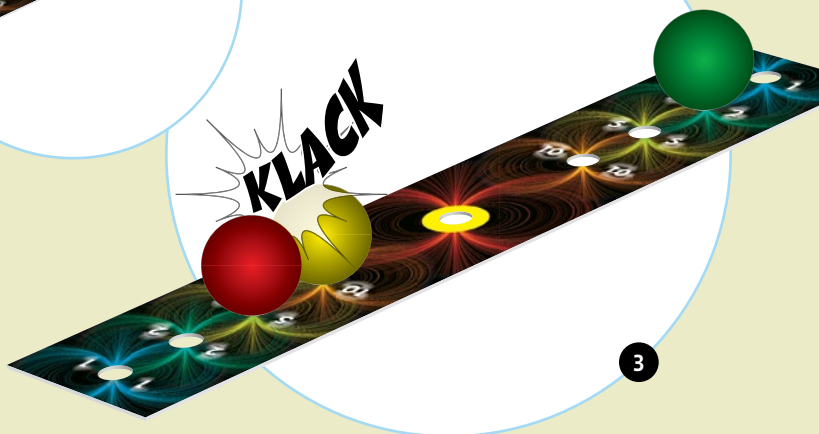
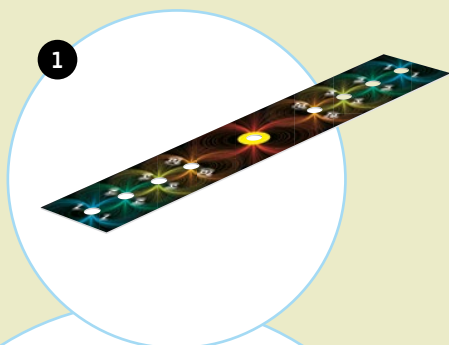
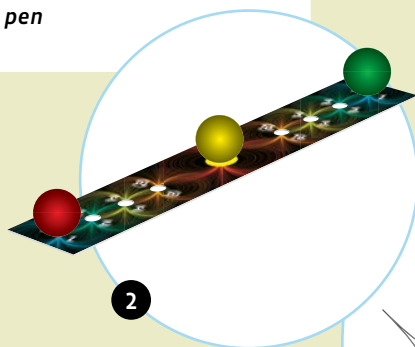

### HERE'S HOW

1. Place the paper strip flat on the table.
2. Position the ball magnets as shown in the illustration.
3. Now, taking turns, each player moves either the red or the green ball one hole at a time toward the center of the strip. At first, of course, it will be easy, but sooner or later the balls will start sensing one another's magnetic force, with a growing risk that they might clack together.

The winner of the round is the last one to have set a ball into a hole without making it clack together with the ball in the center. That player can assign himself or herself the point total written next to the corresponding hole.

After about ten rounds, each player adds up his or her points. Whoever ends up with the most points is the winner.

# Magnetic fishing

## YOU WILL NEED

- bar magnet or horseshoe magnet
- plastic chips
- *tape*
- *string*
- *wooden cooking spoon*
- *colored felt-tip pens*
- *tall box*
- *paper*
- *glue stick*
- *permanent marker*

## HERE'S HOW

1. Decorate the box with sheets of paper with pictures of fish drawn on them.
2. Tape the bar magnet to the string and tie the other end of the string to the end of the cooking spoon.
3. Spread the plastic chips across the bottom of the box.
4. Now you can start your fishing competition. Taking turns, each player lowers the magnet into the box (without looking into it, of course), and fishes out one or more chips.

The winner is the one who catches the most chips. Or, you could use the permanent marker to write different point totals on each of the chips, and the angler with the highest point total wins.

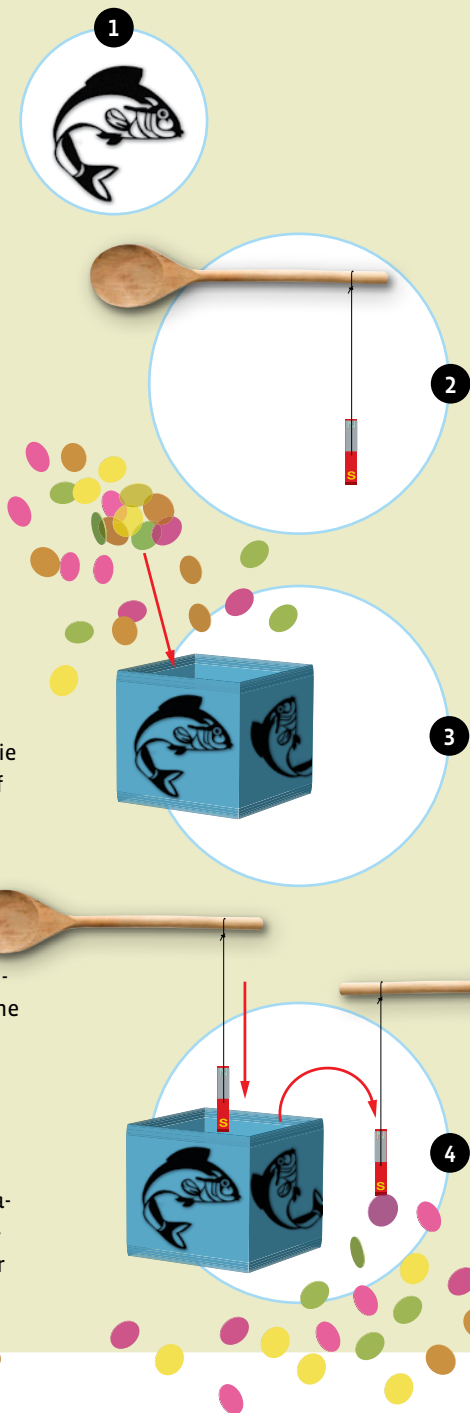



# Invisible attraction

## YOU WILL NEED

- block magnet
- ball magnet
- large sheet of paper
- thick felt-tip markers
- heavy cardboard
- scissors
- glue stick
- watch with second hand or stopwatch
- heavy book

## HERE'S HOW

1. Use the felt-tip markers to draw a thick, winding line with lots of loops on the paper. Mark a starting point and a finishing point. Glue the paper to the cardboard.
2. Set the ball magnet on the starting point and guide it along the curving line toward the finishing point by moving the block magnet against the underside of the cardboard.

## Variations

- a) Along with a few friends, see who can navigate the “race track” the fastest. Deduct points for errors.
- b) You can increase the level of difficulty by increasing the distance between cardboard and magnet, for example by using a thick book. That will make it harder to keep the ball from rolling off in its own direction.

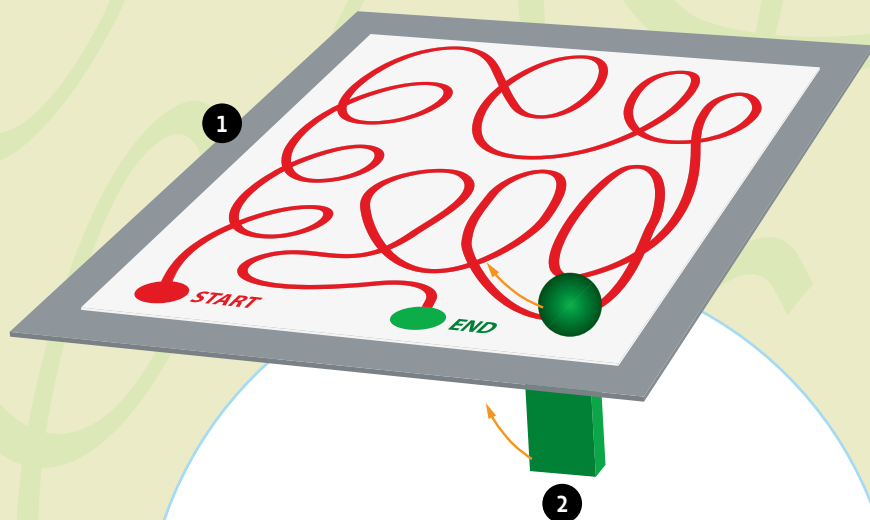

# Magnetic snake and magnetic axle

## YOU WILL NEED

- all the ball magnets
- block magnet
- all the ring magnets
- iron rod

## HERE'S HOW

1. Arrange the ball magnets into a colorful line and set them on the table.
2. By holding the block magnet a slight distance away, you can make your "snake" move. Alternate the ends of the bar magnet to pull the snake or push it away, and to make it move its "head" (the ball at the front).
3. For the magnetic axle, stick two pairs of ring magnets together and arrange the pairs with their mutually repelling poles facing each other. Insert the iron rod through their center holes. Now pull the pairs away from each other until they are at the ends of the rod.
4. Now you can use the block magnet again to move your wheeled axle. **Who can make it go the fastest?**

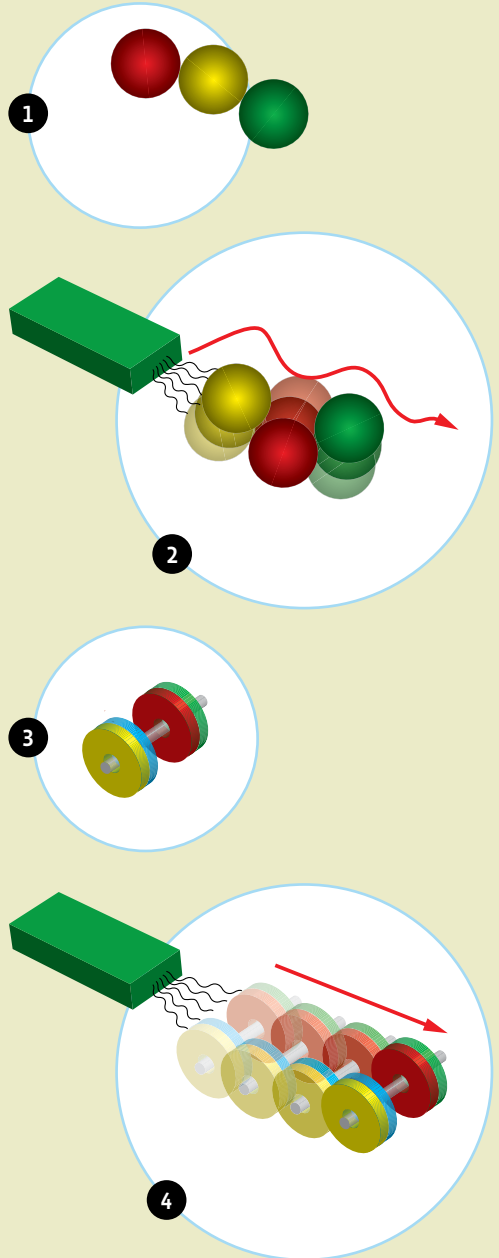



## Kosmos Quality and Safety

More than one hundred years of expertise in publishing science experiment kits stand behind every product that bears the Kosmos name. Kosmos experiment kits are designed by an experienced team of specialists and tested with the utmost care during development and production. With regard to product safety, these experiment kits follow European and US safety standards, as well as our own refined proprietary safety guidelines. By working closely with our manufacturing partners and safety testing labs, we are able to control all stages of production. While the majority of our products are made in Germany, all of our products, regardless of origin, follow the same rigid quality standards.

1st Edition 2011

© 2011 Franckh-Kosmos Verlags-GmbH & Co. KG, Pfizerstrasse 5 - 7, 70184 Stuttgart, Germany

This work, including all its parts, is copyright protected. Any use outside the specific limits of the copyright law is prohibited and punishable by law without the consent of the publisher. This applies specifically to reproductions, translations, microfilming, and storage and processing in electronic systems and networks. We do not guarantee that all material in this work is free from other copyright or other protection.

Conception: Ruth Schildhauer

Editing: Christiane Theis

Project direction: Ita Meister, Kristin Albert

Product development: Elena Ryykin

Design and layout: Atelier Bea Klenk, Klenk/Riedinger

Illustrations: Michael Schlegel, komuniki - print & web, Würzburg

Photos: picsfive, U1, p. 5, p. 19, p. 36; Fredy Thürig, p. 1 top left, p. 18 middle left; Freesurf, p. 1 middle left, p. 20 top; Jan Will, p. 1 top middle, p. 19 bottom right; Charlotte Erpenbeck, p. 1 bottom left, p. 2; Richard Cote, p. 1 middle right; p. 2, p. 18 middle; by-studio, p. 6, p. 7; Karandeuau, p. 7 Tasse; camera-me, p. 7 Tube; abf, p. 7 Besteck; Birgit Reitz-Hofmann, p. 7 Nagel; StepZone, p. 7 Klammern; Pr-gra, p. 7 Münzen; Xuejun Li, p. 7 Flasche; Daniel Bursch, p. 9; Mark FGD, p. 20 top; NatUlrich, p. 24; Irochka, p. 25 top middle, p. 37 middle right; Titelio, p. 25 top left, mattei, p. 25 bottom middle; terex, p. 26 top, p. 36; Freesurf, p. 30, p. 33; Justin Paget, p. 32; Alina Isakovich, p. 37 top; James Steidl, p. 37 bottom right; Frank Wohlfeil, p. 43 left; Bernard BAILLY, p. 43 middle right; oragore, p. 43 bottom; Gentil Francois, p. 44 top left; Kalle Kolodziej, p. 46 Fisch; Stefanie Frey, p. 46 Löffel; (all previous [www.fotolia.com](http://www.fotolia.com)) Allatka, p. 1 top right; Association Curie, Joliot-Curie, nobelprize.org, p. 19 bottom left; Sebastiano del Piombo, p. 25 middle right; John Davis, The Seaman's Secrets (1607), p. 25 bottom right; Gary A Glatzmeier, NSF, p. 34; NASA, p. 35 top; Hannes Grobe, wikipedia, CC-BY-3.0, p. 43 middle (all previous [www.wikipedia.de](http://www.wikipedia.de)); Michael Flaig, pro-studios Stuttgart, U2; Oliver Klasen, Stuttgart, U1, p. 3 top; p. 44 right; gettyimages, p. 26; CERN, p. 42

The publisher has made every effort to identify the owners of the rights to all photos used. If there is any instance in which the owners of the rights to any pictures have not been acknowledged, they are asked to inform the publisher about their copyright ownership so that they may receive the customary image fee.

Packaging design and layout: Atelier Bea Klenk, Klenk/Riedinger

with use of photos from: Charlotte Erpenbeck, Freesurf, Taffi, camera-me, Richard Cote, Mark FGD, Birgit Reitz - Hofmann, D. Fabri (all [www.fotolia.com](http://www.fotolia.com)); Allatka, Nasa (both [www.wikipedia.de](http://www.wikipedia.de)); Oliver Klasen, Stuttgart

1st English Edition © 2012 Thames & Kosmos, LLC, Providence, RI, USA

© Thames & Kosmos is a registered trademark of Thames & Kosmos, LLC.  
Text and Concept: Ted McGuire; Additional Graphics and Layout: Dan Freitas  
Distributed in North America by Thames & Kosmos, LLC, Providence, RI 02903  
Phone: 800-587-2872; Email: [support@thamesandkosmos.com](mailto:support@thamesandkosmos.com)

Printed in China/Imprimé en Chine

